

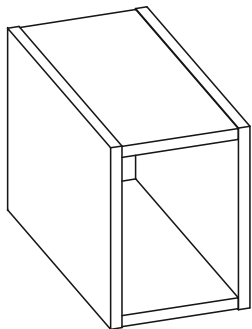

MODUŁ SLIM 20 NEW



P0	ZR2
	
x 4	x 1

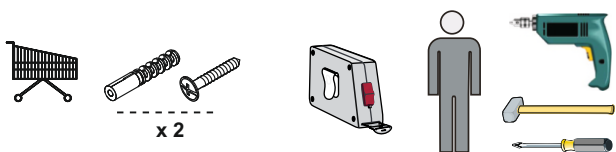

1

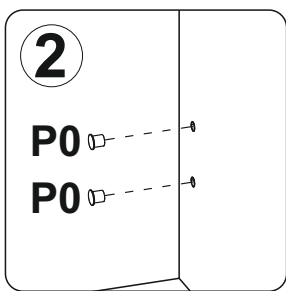
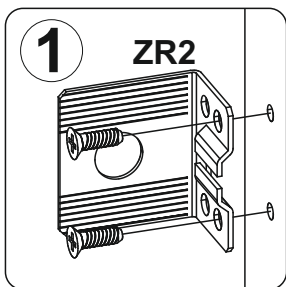
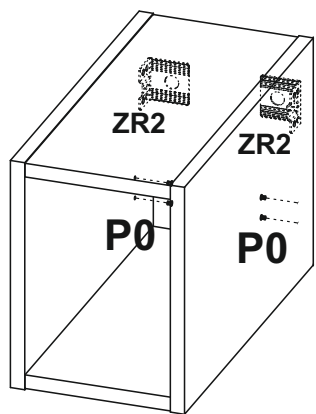

2

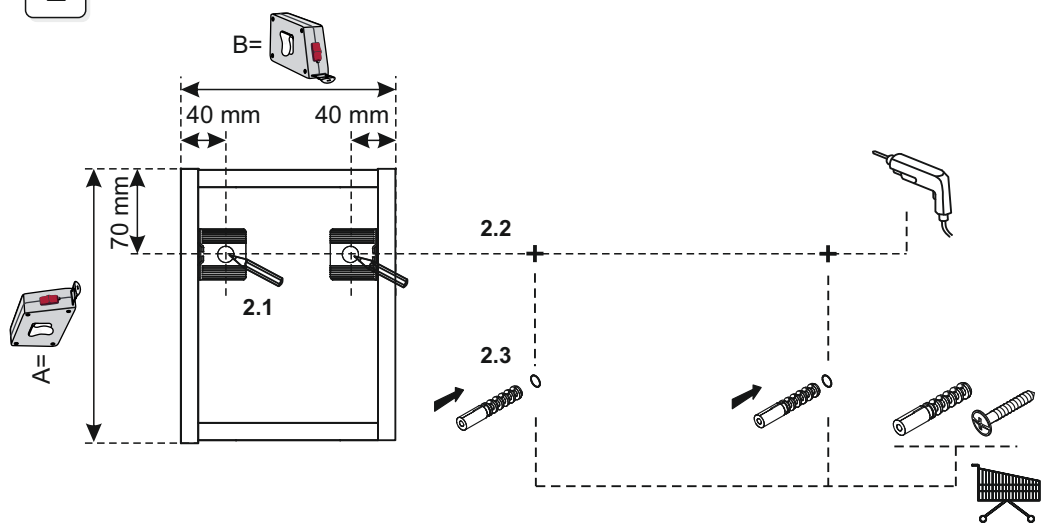

3

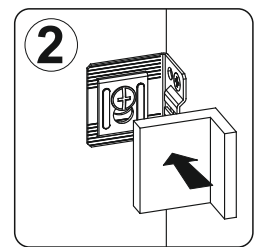
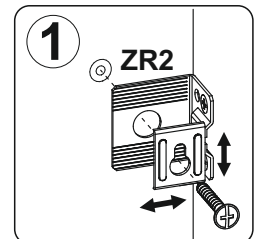
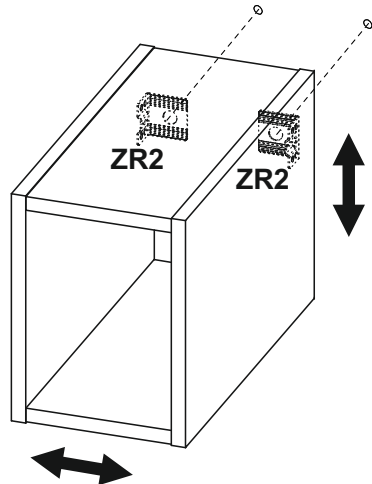

Karta Gwarancyjna
Warranty card
Garantiekarte



Formularz zgłoszenia reklamacji
Complaint submission form
Formular für die Einreichung von Beschwerden



Filmy instruktażowe
Tutorial videos
Lehrvideos